

MADSEN® OTOflex 100

MADSEN OTOflex 100 & OTOSuite Immittance Module

User Guide

Doc. No.7-50-1590-EN/04
Part No.7-50-15900-EN



otometrics
a division of natus

Copyright notice

© 2015, 2019 Natus Medical Denmark ApS. All rights reserved. ® Otometrics, the Otometrics Icon, AURICAL, MADSEN, HI-PRO 2, Otoscan, ICS and HORTMANN are registered trademarks of Natus Medical Denmark ApS in the U.S.A. and/or other countries.

Version release date

2019-12-15 (215614)

Technical support

Please contact your supplier.

Table of Contents

1	Description	4
2	Intended use	4
3	Unpacking	5
4	Installation	5
5	Handling and switching MADSEN OTOflex 100 on and off	11
6	OTOSuite toolbar icons and test controls	11
7	The MADSEN OTOflex 100 keypad	13
8	The MADSEN OTOflex 100 menu	14
9	The MADSEN OTOflex 100 text editor	15
10	Preparing for testing	17
11	Fast routine testing	22
12	Sequence testing	22
13	Screening	23
14	Diagnostic Tympanometry	24
15	Acoustic Reflex testing	26
16	Managing test results in MADSEN OTOflex 100	33
17	Other references	35
18	Service, cleaning and calibration	35
19	Technical specifications	40
20	Definition of symbols	47
21	Warning notes	49
22	Manufacturer	51

1 Description

MADSEN OTOflex 100

MADSEN OTOflex 100 is a compact and portable wireless immittance test device.



- You can operate MADSEN OTOflex 100 from the PC's keyboard/mouse with the OTOSuite Immittance module acting as the display, or operate the device itself as a stand-alone unit.
- From the OTOSuite Immittance module, which is NOAH compatible, you can monitor test results, create User Tests, store and export data, and print reports.

Bluetooth

MADSEN OTOflex 100 connects with OTOSuite via Bluetooth™, which provides wireless connection between MADSEN OTOflex 100 and OTOSuite up to a range of approximately 10 metres (approx. 33 ft).

2 Intended use

MADSEN OTOflex 100 and the Immittance module

Users: audiologists, ENTs and other health care professionals in testing the hearing of infants, children and adults.

Use: clinical, diagnostic and screening tympanometry and reflex measurements.

MADSEN OTOflex 100 uses technologies which are highly effective for clinical and screening purposes. Tympanometry and acoustic reflex measurements measure the mechanical response of the middle ear and form a basis for evaluating whether the related physiological structures are functioning correctly or not.

The MADSEN OTOflex 100 probe is extremely lightweight (only 4.5 grams), and comes with comfortable, easy to insert ear-tips. This makes it ideal for use with children and adults.

MADSEN OTOflex 100 can be configured for a wide variety of tests, and it can be operated entirely manually or programmed for the user's own combination of manual and automatic operation. In user-programmable tests the user can select the default parameters of a particular test, and combine tests to form a sequence of preset tests.

2.1 Typographical conventions

The use of Warning, Caution and Note

To draw your attention to information regarding safe and appropriate use of the device or software, the manual uses precautionary statements as follows:

Warning • Indicates that there is a risk of death or serious injury to the user or patient.

Caution • Indicates that there is a risk of injury to the user or patient or risk of damage to data or the device.

Note • Indicates that you should take special notice.

To obtain a free printed copy of the user documentation, contact Natus Medical Denmark ApS (www.natus.com)Inmedico ([Global terms.InMedicoWebadress](#))).

3 Unpacking

1. Unpack the device carefully.
When you unpack the device and accessories, it is a good idea to keep the packing material in which they were delivered. If you need to send the device in for service, the original packing material will protect against damage during transport, etc.
2. Visually inspect the equipment for possible damage.
If damage has occurred, do not put the device into operation. Contact your local distributor for assistance.
3. Check with the packing list to make sure that you have received all necessary parts and accessories. If your package is incomplete, contact your local distributor.

4 Installation

Install OTOsuite on the PC before you connect to MADSEN OTOflex 100 from the PC.

For OTOsuite installation instructions, see the OTOsuite Installation Guide, on the OTOsuite installation medium.

- [Desktop installation ▶ 7](#)
- [Desktop installation ▶ 7](#).

4.1 Wall mount installation

1. Drill 2 x 6 mm diameter holes 130 mm (5.12") apart.
2. Insert rawl plugs.
3. Insert the screws with the washers mounted, through the backplates of the wall mount.

- A. 2 screws
- B. 2 washers
- C. 2 rawl plugs

- D. washer
- E. wall mount backplate
- F. plastic shelf

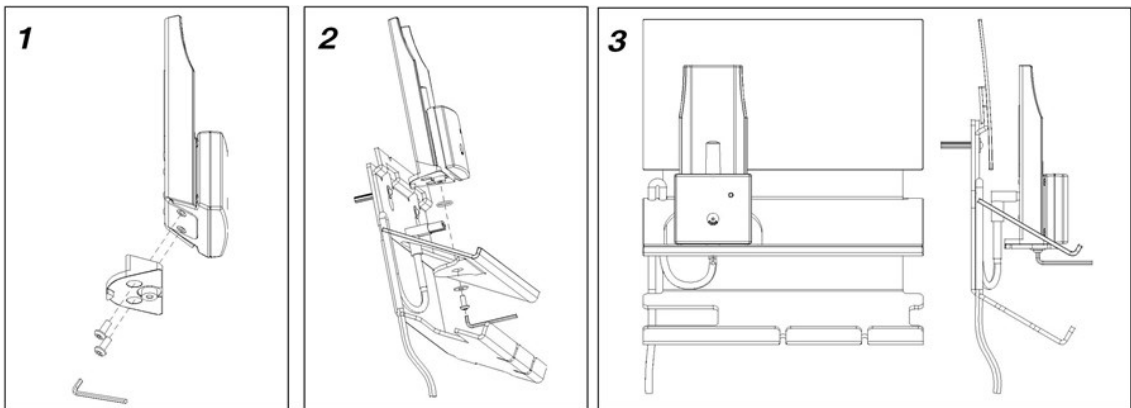
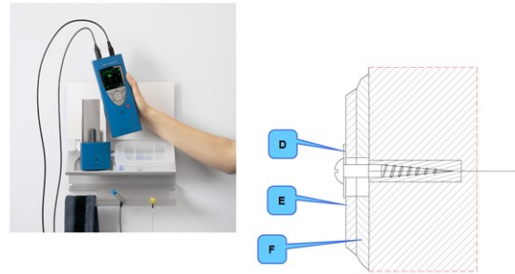
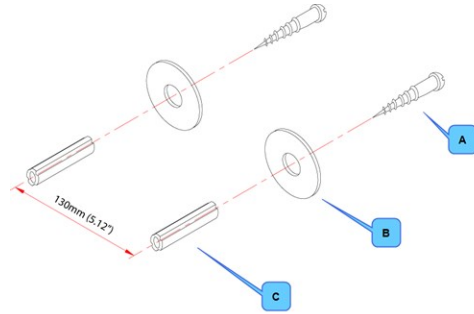

4.2 Desktop installation

Mount the charger on the charger base as shown below.

1. Use the hexagonal key to screw the hexagonal screws into place.
2. Tighten the screws well so that the charger is stable when you place MADSEN OTOflex 100 in the charger.

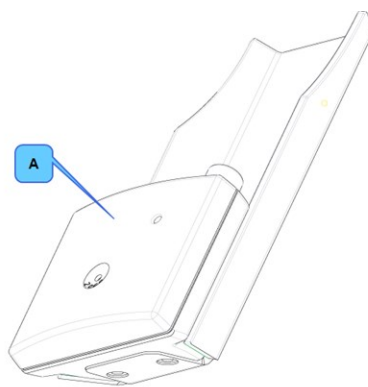

A. Charger body

B. Charger base

C. Hexagonal screws

D. Hexagonal key

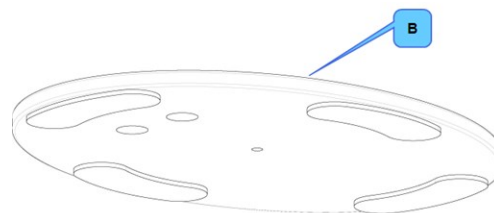

A. Base

B. Hexagonal key

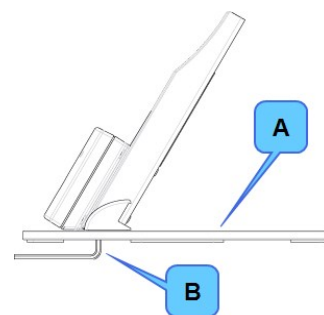

4.3 Powering the device

MADSEN OTOflex 100 is powered by batteries.

- Rechargeable NiMH batteries
The device is delivered with rechargeable NiMH batteries.
- Alkaline batteries
If needed, the device can be powered by non-chargeable Alkaline batteries.

Caution • Use only the battery types listed in [Technical specifications](#) ► 40.

Inserting batteries

1. The batteries and the battery cover are delivered in a small bag.

Note • Do not insert the battery cover in the battery compartment if the battery compartment is empty. If you do, the cover will lock in place inside the device.

2. Insert the batteries as shown. If you are in doubt, look inside the battery compartment where you will see small red plus signs indicating which way the batteries fit.

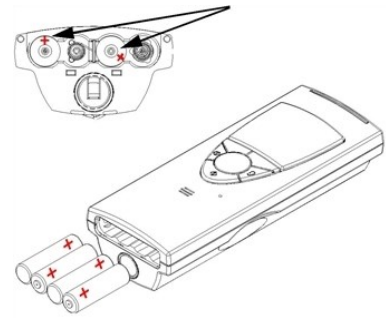

3. To put the battery cover back in place, insert the cover with the curved edge facing upwards in the opening. Press the cover inwards and downwards until it clicks into place.
4. The next time you change batteries, press the cover inwards and upwards until it is released and snaps out of place.

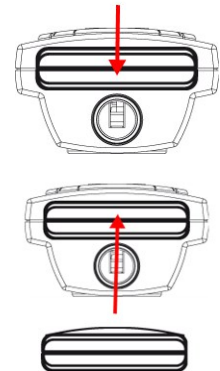

Set the battery type in the device

The device is delivered preset for rechargeable NiMH batteries.



Warning • If you use the device with Alkaline batteries, always switch off the mains power supply to the charger. Failure to do so may cause the Alkaline batteries to leak and cause damage to the device.

1. If you are in doubt of the setting, or if you are using Alkaline batteries, check the battery type and the setting in the device: When MADSEN OTOflex 100 is ready for use, switch it on: Press and hold the **On/Off** key on the keypad.
2. Press **Select** to access the **Menu** followed by **Advanced.. > Device Settings..** and scroll to **Battery type**.
3. Press **Select** to toggle to the correct battery type. You can choose between NiMH (rechargeable) and Alka(l)ine).
4. Press the left softkey to exit.

- If needed, press and hold the **On/Off** key on the keypad to switch off the device.

Power indicator

An icon in the top right corner of MADSEN OTOflex 100 shows the type of powering used.

	MADSEN OTOflex 100 receives power from the charger.
	MADSEN OTOflex 100 is powered by batteries.

4.4 Powering the charger

Connecting the charger to the mains power outlet

Warning • Operating at the wrong voltage may blow the fuses! See the label on the charger for input voltage.

- Before you connect the power cable to the charger, make sure that the voltage from the electrical power outlet matches the voltage shown on the identification label on the charger.
- Connect the charger to the mains power outlet. The device is delivered preset for rechargeable NiMH batteries.
- When you are not using the device, leave it in the charger so that it is always ready for testing.

Warning • If you use the device with Alkaline batteries, always switch off the mains power supply to the charger. Failure to do so may cause the Alkaline batteries to leak and cause damage to the device.

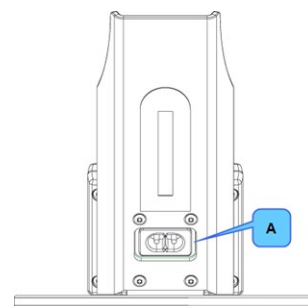

A. Power socket

Charging the device



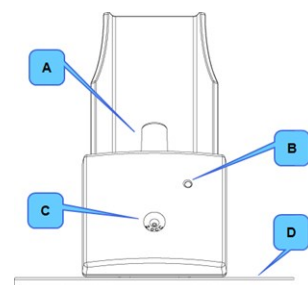

See [Powering the device](#) ► 7.

- Insert rechargeable NiMH batteries in the device.
 - Place the device in the charger.
 - Leave the device to charge for at least 14 hours, and preferably overnight, before putting it into use.
- The batteries will reach full capacity when they have been recharged a couple of times.



A. Charger tab for charging the device
 B. Charging indicator
 C. Probe test cavity
 D. The charger base

Charging status	
When the device is charging, the charging indicator on the front of the charger indicates the following:	
Green, steady:	The device is not charging. Charging is resumed when the device is reinserted into the charger or the device is turned on.
Amber, steady:	The device is charging. Charging is discontinued automatically based on a timer to ensure that batteries are not over-charged.
Amber, flashing:	The charger is faulty. Contact your supplier.

Device status		
Powered by charger	When the device is charging, a small power plug icon is shown in the top right corner of the screen.	
Powered by batteries only	When the device is powered by batteries only, i.e. when it is not placed in the charger or when Alkaline batteries are used, it shows the approximate remaining capacity of the batteries in the top right corner of the screen.	  

4.5 Connecting MADSEN OTOflex 100 to OTOSuite

When you use MADSEN OTOflex 100 for the first time, run the Configuration Wizard to set up the connection between MADSEN OTOflex 100 and OTOSuite. After you have configured OTOSuite for the first time, if MADSEN OTOflex 100 is turned on when you open the Control Panel in OTOSuite, then MADSEN OTOflex 100 will connect to OTOSuite automatically. Otherwise, you can connect MADSEN OTOflex 100 as follows:

1. Switch on the device.
2. Launch OTOSuite.
3. In the OTOSuite toolbar, click **Control Panel**.
4. In the Control Panel, click **Connect**.

5 Handling and switching MADSEN OTOflex 100 on and off

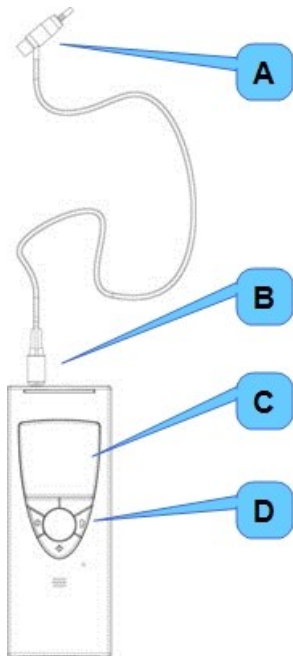

- A. Probe
- B. Probe plug
- C. Screen
- D. Keypad

Handling

To operate MADSEN OTOflex 100, hold it with one hand (left or right). Use your thumb to press the keys on the keypad and turn the scroll wheel.

Switching on MADSEN OTOflex 100

 Press and hold the **On/Off** key on the keypad until the start-up screen appears.



Switching off MADSEN OTOflex 100



 Press and hold the **On/Off** key on the keypad until the message "Power Off" appears.

6 OTOsuite toolbar icons and test controls

Immittance module toolbar









The icons available in the toolbar depend on the test function that you have selected.

General Immittance icons	
	<p>Get Test Results from device (Ctrl + G)</p> <p>Opens the dialog box for uploading patient folders from the test device.</p>
	<p>Select Device</p> <p>Opens the dialog box for selecting a specific test device.</p>

Tympanometry toolbar	
	<p>Show Previous Curves/Show Next Curves Toggles between specific curves on the tympanogram.</p>
	<p>Admittance is selected - change to Conductance/Susceptance Conductance/Susceptance is selected - change to Admittance Toggle to see the admittance components conductance and susceptance, or admittance data.</p>
	<p>Auto Scale (tympanogram) Click to select/deselect autoscaling of a tympanogram in order to display the entire curve. When you change the ear or the patient, the scale will revert to the default scale.</p>

Reflex toolbar	
	<p>Show Previous Curves/Show Next Curves Toggles between the visible reflex curves.</p>

Test controls

	Starts/pauses a sequence.
	Starts a test.
	Starts a fully automatic reflex test.
	Starts a semi-automatic reflex test.
	Starts stimulus to present a single stimulus intensity.
	Stops the test immediately.
	Pauses the progress of a sequence. When this button flashes, click again to resume testing.
	Skips the ongoing measurement and continues with the next.
	Controls pressure in ETF-P.



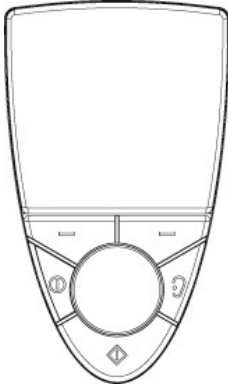





7 The MADSEN OTOflex 100 keypad



MADSEN OTOflex 100 has 1 scroll wheel and 5 keys.

- *Scroll wheel*
 - Turn the scroll wheel to the right or left to highlight areas on the screen.
- *Keys*
 - Press and release the keys to activate most functions.
 - Press and hold the keys for instance to turn the device on or off, or to run a full test sequence.

Key	Function
	<ul style="list-style-type: none"> • On/Off <ul style="list-style-type: none"> – Press and hold this key to turn the device on or off. • Select test screen <ul style="list-style-type: none"> – Press this key to toggle between the test screens Tympanometry, Reflex Screening, Reflex Threshold, Reflex Decay, and ETF-P
	<ul style="list-style-type: none"> • Select ear <ul style="list-style-type: none"> – Press this key to select the ear to be tested, or the ear to be reviewed (when you view data). • Pressure release during testing <ul style="list-style-type: none"> – If the patient is troubled during testing, press this key to stop the test.
	<ul style="list-style-type: none"> • Select a menu item <ul style="list-style-type: none"> – Selects an item from the menu – Activates the scroll function – Toggles between test screens and menu screens. • Enter the menu <ul style="list-style-type: none"> – Activates the menu from the Tymp or ETF screens. Scroll to move between choices, and then press this key to select. Press the right softkey to return to the Tymp or ETF screen. • View tympanometry data <ul style="list-style-type: none"> – In the Tymp screen, press and hold this key to select tympanometry data view. Press and hold this key to return to the Tymp screen. – Press and hold this key to activate the scroll wheel in the Tymp Data and Tymp test screens. Selects a test screen and deactivates the scroll wheel.

Key	Function
	<ul style="list-style-type: none"> • Softkeys Press these keys to select whatever is shown on the screen directly above the key. <ul style="list-style-type: none"> – <i>Example:</i> If  is shown above the left key, press this key to toggle between curves 1, 2, or 3. – Press the left-hand key to return to the previous screen when  is displayed. – Press the right-hand key to go directly to the testing screen when  is displayed. – Press and hold the left-hand key to view patient, user, and device information. – Press and hold the right-hand key to start an entire test sequence.
	<ul style="list-style-type: none"> • Scroll wheel <ul style="list-style-type: none"> – Scroll to highlight the Menu icon  and press the Select key  to select. – Scroll to highlight menu items or test options. Press the Select key  to select. – Scroll to move between tests within a sequence. – Highlight an item you wish to select within a Reflex screen, e.g a single frequency, and press the Select key  to scroll through presentation levels. – Scroll to increase or decrease a selected value.

8 The MADSEN OTOflex 100 menu

Main menu	Function
Start Sequence	For starting a sequence of tests.
Test Selector	For selecting the test you wish to perform. See Using a test setup ▶ 20 .
Print/Printers..	For selecting direct printout.
Patient & User	For entering patient and user information. See The MADSEN OTOflex 100 text editor ▶ 15 .
My Settings..	For loading settings or saving current settings.
Done!	For selecting the Done! prompt. This prompt appears whenever a step in the test procedure has been done, and takes you to the next step. See Test flow setup ▶ 20 .
Probe Check	For selecting the probe check, which should be carried out daily. See Daily probe check ▶ 18 .

Main menu	Function
---	For selecting frequently used settings for the displayed test type.



More settings..	For selecting additional settings for the displayed test type.
Manage Test Res(ults)	For loading a previously tested patient, deleting tests, etc. See Managing test results in MADSEN OTOflex 100 ► 33.
Procedure options..	For setting up routine testing.
Advanced..	For selecting advanced features.

9 The MADSEN OTOflex 100 text editor

If you are testing using MADSEN OTOflex 100 as a stand-alone device, use the text editor to enter patient data in MADSEN OTOflex 100.

Entering data

In some screens you can enter text and numeric values.



Keypad	Function
Left softkey	Cancel <ul style="list-style-type: none"> Do not use the edited text
Right softkey	OK <ul style="list-style-type: none"> Accept the edited text
	Select <ul style="list-style-type: none"> Press to access field Press to enter character Press and hold to enter character selection mode
	Scroll wheel <ul style="list-style-type: none"> Scroll to highlight field Scroll to select character

1. Scroll to the field where you wish to enter data.
2. Press **Select** to access the field. The field displays a small highlighted square.
3. Turn the **Scroll Wheel** until the desired digit or letter is displayed and press **Select**.
4. Continue until you have entered the data.
5. Press **OK** to confirm.
6. Turn the **Scroll Wheel** to go to the next field, and press **Select** to access the field.

- If you need to move the cursor to insert or delete letters/digits in the data field, see below for editing entered data.

Editing data

You can edit data in the **Patient & User** screen.

Keypad	Function
Left softkey	DEL (Delete) <ul style="list-style-type: none"> Press to delete character
Right softkey	INS (Insert) <ul style="list-style-type: none"> Press to insert space for a character
	Character selection enabled
	Select <ul style="list-style-type: none"> Press to return to character entry mode
	Scroll wheel <ul style="list-style-type: none"> Scroll to highlight character Scroll to select character

- Scroll to the field you wish to edit and press **Select** to access the field.
- Press and hold **Select** to access character selection mode. The bottom of the screen shows double arrows  to indicate that you can scroll to the desired position in the field.

Editing characters

- Scroll to the desired position.
- Press **Select** and scroll to change the character as needed.

Deleting characters

- To delete a character, scroll to the character to be deleted.
- Press the **DEL** (Delete) softkey.

Editing settings

- Scroll to the setting you wish to change.

There are two main methods of editing data such as measurement settings:

- Settings with two value options*
Press **Select** to toggle the value in the settings field.
- Settings with several value options*
Press **Select** to access the settings field, and use the **Scroll Wheel** to scroll to the desired setting.

10 Preparing for testing

To prepare for testing:

- If this is the first test of the day, make a probe check.
- Connect the probe, and, if needed, the insert phone.
- Prepare MADSEN OTOflex 100 and the Immittance module: select the patient and test setup. See the OTOSuite User Guide.
- Prepare the patient.
- Prepare probe and eartip.

10.1 Preparing the probe

Connecting the probe

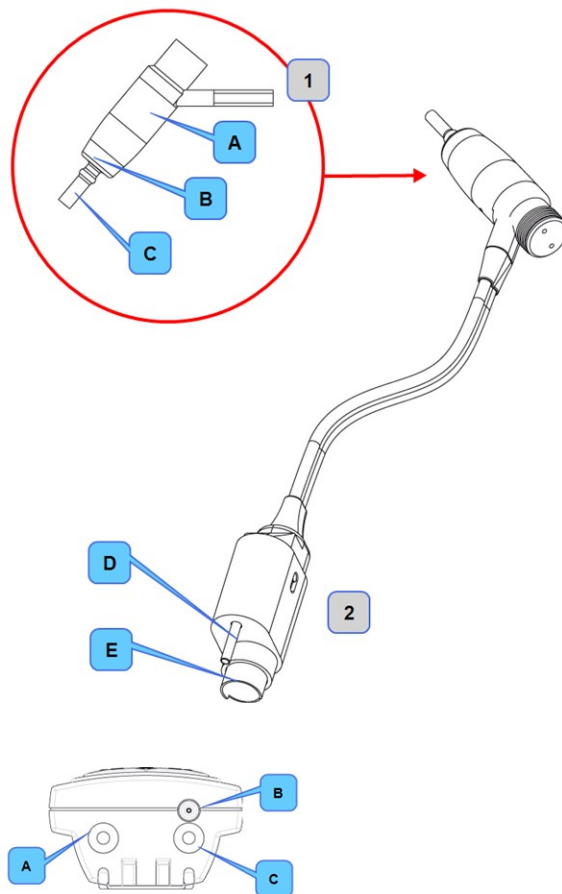

1. The probe

- A. Probe body
- B. Threaded ring
- C. Probe tip

2. The probe plug

- D. Air connector
- E. Transducer connector

Top of device

- A. Contralateral socket
- B. Pneumatic connection
- C. Probe socket

Connecting probe and insert phone

The MADSEN OTOflex 100 probe

- Plug the probe into the probe socket. Make sure that you insert the pin for the pneumatic pump into the pneumatic connection.

The E-A-RTONE® 3A insert phone

- If needed, plug the E-A-RTONE® 3A insert phone into the contralateral socket.

Disconnecting probe and insert phone

The probe plug and the contralateral plug are equipped with a locking mechanism: When you disconnect the probe, do not pull the plug by the cable. Grip the probe by the sleeve of the plug and free it by gently pulling it out of the socket.

10.2 Daily probe check

To make sure that the probe is functioning correctly, it is recommended that you perform a probe check at the start of each day.

Note • *If your test environment changes, for instance if there is an increase in humidity, or if you are going to test at an altitude different from the one set in MADSEN OTOflex 100, adjust the altitude setting and make another probe check.*

1. Make sure that the probe tip has been cleaned and disinfected before you place it in the test cavity. This is to make sure that the probe tip and filter do not influence the probe test, and that the test cavity is not contaminated.
2. Select **Menu > Probe Check**.
3. Insert the probe tip without eartip in the test cavity in the charger. The probe check starts automatically. The probe is checked for occlusion and leakage. If the probe is OK, the probe is automatically calibrated to 2cc.

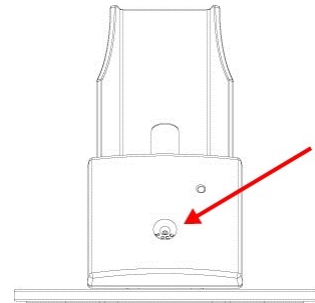

If there is a probe error

In case of a probe error, check the following:

- Make sure that the threaded ring holding the probe tip in place is firmly tightened.
- Make sure that the sound channels in the probe tip are clear and that the probe is connected.
- Make sure that the probe tip goes into the cavity at a 90° angle.

If the probe is faulty, contact an authorized service department for repair.

10.3 Fitting the eartip on the probe

Warning • Choking hazard! Do not leave eartips unsupervised within the reach of children.

Note • Accurate testing is only guaranteed if you use the eartips approved specifically for MADSEN OTOflex 100 by Otometrics.

Note • Check the sound channels in the probe tip every time you have used the probe. Even small amounts of cerumen or vernix can block the sound channels. Clean the sound channels if needed.

Warning • The eartip can be used for both ears. If you suspect infection in one ear, exchange the eartip and clean the probe tip before you continue testing on the other ear.

1. Select an eartip that fits the patient's ear canal.
2. Gently push and twist the eartip clockwise onto the probe tip, until it rests firmly against the base of the probe. Make sure that the eartip covers the collar (C) of the probe tip.



10.4 Fitting the probe in the patient's ear

Warning • The eartip can be used for both ears. If you suspect infection in one ear, exchange the eartip and clean the probe tip before you continue testing on the other ear.

1. Fit the eartip on the probe.
2. To stabilize the probe and to avoid blocking the probe against the ear canal of the patient, grasp the pinna and gently pull the pinna back and slightly away from the patient's head.
 - For adults: pull the pinna upwards and back.
 - For infants and children: pull the pinna downwards and back.
3. Insert the probe in the patient's ear canal, twisting the eartip slightly as you insert it.
4. Make sure that the eartip fits well. Any leakage may interrupt the test.

Caution • Never insert the probe without a suitably sized eartip. Using a probe with an unsuitably sized eartip or applying excessive force may irritate the ear canal.

Warning • Be careful not to insert the probe too far into the ear canal of premature babies and newborns.

To compensate for spontaneous movements of the patient’s head:

- Place the probe cable behind the patient’s neck.
- To keep the cable in place, place a weighted shoulder harness over the cable, from front to back of the patient, across the shoulder opposite the ear being tested.
- Make sure that the cable is not drawn tight, as this may result in the probe being pulled out of position.

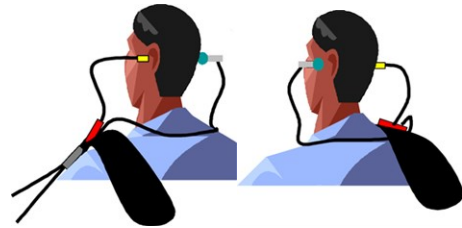

During testing, MADSEN OTOflex 100 and the Immittance module will show a probe icon indicating leakage, if any.

10.5 Test flow setup

1. When you switch on the device, a new patient folder is created automatically.
2. The **Patient & User** screen is shown. Enter the patient and user data .
3. Set up MADSEN OTOflex 100 to facilitate the process of testing, handling patient data, and continuing with the next patient:
 - Select **Menu > Procedure options.. >**
 - Set the following settings to **On**, if needed:

Setting	What happens if On is enabled?
Done? prompt	The Done? prompt will appear when you have performed the same number of tests on both ears. of the patient.
Print when done?	The results will be printed if you press Yes in response to the prompt. When printing is done, the Done? prompt reappears. Select Yes to continue. A new patient folder is created.
Patient	The Patient & User screen appears for creating a new patient folder.
Settings prompt	When you have entered patient data, the Load Settings screen appears if any customized setups are available. Select the test setup of your choice, and continue with testing.

4. If needed, press the **On/Off** key one or more times to select another test type.

10.6 Using a test setup

If you want to use a test setup different from the one currently selected, do one of the following:

In MADSEN OTOflex 100

1. Select **Menu > My Settings.. > Load Settings.**

If **Menu > Procedure options.. > Settings** prompt is set to **On**, you will automatically be prompted to load a test setup.

2. Scroll to the test setup of your choice and press **Select.**

In OTOSuite



- Click to open the **Test Selector** window. This window enables you to load user defined tests, special test setups, and factory default tests.

10.7 Leakage and other probe problems

Testing may be complicated by a number of factors which can result in leakage or probe problems.

Leakage - possible causes:

- The eartip does not fit well
- The eartip is not inserted properly in the ear canal
- The probe tip opening is blocked by the wall of the ear canal
- The eartip may be old or hardened
- the threaded ring holding the probe tip has not been tightened properly
- The pneumatic probe plug has not been inserted properly in OTOflex
- the probe tip has not been tightened properly

Probe problems can be caused by:

- an occluded probe
- a blocked wax filter

Probe status

MADSEN OTOflex 100	OTOSuite	Description
		The probe seal is OK
		The probe is blocked
		There is a probe leak
		The probe is not fully inserted

11 Fast routine testing

1. When you switch on the device a new patient folder is created automatically.
2. Enter patient information (if the device is not connected to OTOSuite).
3. Select the user (if the device is not connected to OTOSuite).
4. Insert first the contralateral insert phone and then the MADSEN OTOflex 100 probe.
5. Press the right softkey for 1 second to start the sequence (automatic or manual).
6. Press the **Ear Selector** key to switch ear.
7. Insert first the contralateral insert phone and then the MADSEN OTOflex 100 probe.
8. Press the right softkey for 1 second to start the sequence (automatic or manual).
9. Press the right softkey under **Yes** to confirm that testing is done (if the device is not connected to OTOSuite).
10. Select **Menu > Print/Printers..** if you wish to print out a report. Press the right softkey under **Yes** to confirm that the report is **OK** and that testing is done.

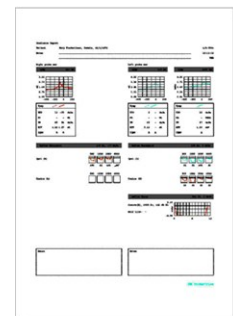

12 Sequence testing

You can perform the immittance tests in sequences.

- MADSEN OTOflex 100: **Menu > Procedure options.. > Sequence**
- OTOSuite: In the **Sequence** field in the **Control Panel** click the drop-down list to select.

You can choose between

- **T + RS** (Tympanometry + Reflex Screening)
- **T + RT** (Tympanometry + Reflex Threshold)
- **T + RT + RD** (Tympanometry + Reflex Threshold + Reflex Decay)
- **Off** (MADSEN OTOflex 100)
The press-and-hold function is disabled, and only the currently selected measurement type will be performed.

13 Screening

You can perform Tympanometry + Reflex Screening (T+RS) as a sequence from the Tympanometry test screen.

Note • The safety intensity level cannot be exceeded in screening mode.

Note • You can use either ordinary eartips or screening eartips for screening. If you are using screening eartips and the setting **Auto start on seal** is set to **On**, the test will start with tympanometry testing and continue automatically from tympanometry to reflex screening when seal is obtained, i.e. when the screening eartip is pressed gently against the ear.

Note • To avoid automatic testing being interrupted because of high stimulus intensity levels when reaching the warning limits, it is recommended that you set the max. intensity to 95 dB HL.

Preparing for testing

1. Do as described in [Preparing for testing ► 17](#).
2. If contralateral stimulation is used in the test, make sure that both the ipsilateral probe and the contralateral phone are in place before you start the measurement.
3. Ask the patient to sit very still and quiet during the test, without moving head or jaw.
4. If needed, toggle the **Ear Selector** to select the ear on which you wish to start the test.

Procedure







The test starts automatically with tympanometry testing and continues automatically to reflex screening.

1. In order to prepare MADSEN OTOflex 100 to start measuring as soon as seal is achieved, do the following:

If you are using OTOSuite:

- In the **Tympanometry** screen, select **T + RS** in the **Sequence** field at the bottom of the Control Panel.
- Without applying the eartip to the patient's ear click **Start** on the Control Panel.



Procedure	
<p>If you are using MADSEN OTOflex 100:</p> <ul style="list-style-type: none"> – Select Menu > Procedure options.. > T + RS. – Without applying the eartip to the patient’s ear press the right-hand softkey. 	
<p>2. If needed, toggle the Ear Selector to select the ear on which you wish to start the test.</p>	 or 
<p>3. Apply the probe to the patient’s ear with a steady grip. The test starts automatically as soon as a good probe fit with an airtight seal is achieved.</p>	
<p>Warning • <i>If the patient is troubled by the test, stop the test. The test is interrupted and the pump pressure is relieved immediately. Already measured results are kept.</i></p>	 or 
<ul style="list-style-type: none"> – To interrupt the test, click/press Pause. – To resume the test, click/press Pause again. After the pause, the test resumes at the intensity it came to or was interrupted in. 	
<p>The test starts automatically with tympanometry testing and continues automatically to reflex screening.</p>	









14 Diagnostic Tympanometry

Note • *It is recommended that you perform a tympanometric test before making any acoustic reflex measurement, and determine the acoustic reflex threshold before making a reflex decay measurement.*

The default setup available in the tympanometry test is designed for any of the tympanometry tests you can perform. Adjust the settings to suit your purposes.

Preparing for testing

1. Do as described in [Preparing for testing ► 17](#).
2. If contralateral stimulation is used in the test, make sure that both the ipsilateral probe and the contralateral phone are in place before you start the measurement.
3. Ask the patient to sit very still and quiet during the test, without moving head or jaw.
4. If needed, toggle the **Ear Selector** to select the ear on which you wish to start the test.

Procedure	
1. Select the Tympanometry test screen.	
If you are using OTOSuite: <ul style="list-style-type: none"> In the Tympanometry screen, click Start on the Control Panel. 	
If you are using MADSEN OTOflex 100: <ul style="list-style-type: none"> Press the right-hand softkey. 	
Warning • If the patient is troubled by the test, stop the test. The test is interrupted and the pump pressure is relieved immediately. Already measured results are kept.	 or 
Already measured results are kept.	
The test progresses as follows: <ul style="list-style-type: none"> The pump increases the pressure to the set value, and the sweep starts. The admittance for each pressure point is plotted out on the screen and forms the tympanogram curve. 	
During the measurement, two diamond markers are shown: <ul style="list-style-type: none"> an admittance marker just to the right of the admittance axis, indicating the current admittance a pressure marker below the pressure axis, indicating the current pressure. 	
<ul style="list-style-type: none"> To interrupt the test, click/press Pause. 	
<ul style="list-style-type: none"> To resume the test, click/press Pause again. After the pause, the test resumes at the intensity it came to or was interrupted in. 	
2. To make a new sweep, click/press Start . You can save up to 3 separate measurements for each ear.	 or 
3. When you have finished testing one ear, switch ears, if needed.	
4. To continue testing, click/press Start and test the other ear.	

The diagnostic tympanometry result

OTOSuite



Auto Scale (tympanogram)

Autoscaling adjusts viewing dynamically according to the highest of all currently displayed curves, so that you can visually compare ear results.

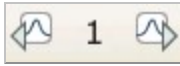

Curve selector

Click on one of the curves in this icon group to view a specific curve on the tympanogram.

The **Tympanometry** screen shows

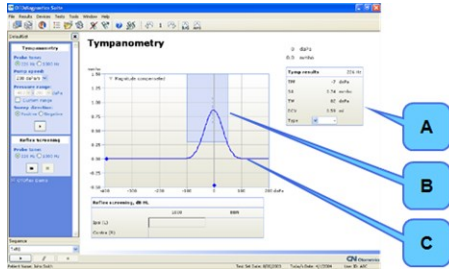

- A. Tymp results, showing:
 - Probe tone
 - TPP (Tympanometric Peak Pressure)
 - SA/SC (Static Admittance/Static Compliance)
 - TW (Tympanometric Width)
 - ECV (Ear Canal Volume)
 - Type, if selected (if normal region and baseline are enabled).
- B. the tympanometric curves
- C. norm area, if selected

MADSEN OTOflex 100

Tympanometric test results are shown in a results view:

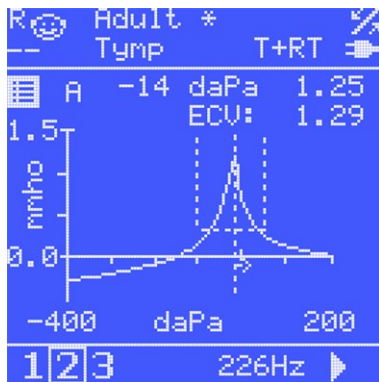

- Use the **Test Selector** and scroll to the Tympanometry Data screen, or press **On/Off** briefly.
- To display additional results, press **Select** for 1 second. To return to the standard tympanometry view, press again.

15 Acoustic Reflex testing

Note • It is recommended that you perform a tympanometric test before making any acoustic reflex measurement, and determine the acoustic reflex threshold before making a reflex decay measurement.

With MADSEN OTOflex 100, automatic or semi-automatic testing automatically determines acoustic reflexes using different stimulus levels.

High intensity levels

Note • To avoid automatic testing being interrupted because of high stimulus intensity levels when reaching the warning limits, it is recommended that you set the max. intensity to 95 dB HL.

Whenever a stimulus level exceeds the warning level (> 108 dB SPL re 2 cc corresponding to >=115 dB SPL in 0.5 cc), the stimulus intensity value will start flashing and automatic testing is paused. You are then prompted to decide whether to continue or to move on to the next stimulus type.

Warning • The sound pressure level in the ear canal increases when you test patients with small ear canals. Always comply with local practice and recommendations for presenting loud stimuli.

15.1 Reflex Threshold testing

Before reflex testing

1. Do as described in [Preparing for testing ► 17](#).
2. Inform the patient about the high stimulus levels in the test.
3. Ask the patient to sit very still and quiet during the test, without moving head or jaw.
4. If contralateral stimulation is used in the test, make sure that both the ipsilateral probe and the contralateral phone are in place before you start the measurement.
5. If needed, toggle the **Ear Selector** to select the ear on which you wish to start the test.
6. Select the Reflex Threshold test screen.



During testing



Warning • If the patient is troubled by the test, stop the test. The test is interrupted and the pump pressure is relieved immediately. Already measured results are kept.





Procedure

Note • To avoid automatic testing being interrupted because of high stimulus intensity levels when reaching the warning limits, it is recommended that you set the max. intensity to 95 dB HL.

Automatic RT testing	
If you are using OTOsuite: – In the Reflex Threshold screen, click Start on the Control Panel.	
If you are using MADSEN OTOflex 100: – Press the right-hand softkey.	
The test runs a fully automatic threshold search for the preset stimuli.	

Semi-automatic RT testing	
If you are using OTOsuite: – In the Reflex Threshold screen, click Start on the Control Panel.	
If you are using MADSEN OTOflex 100: – Press the right-hand softkey.	
The test runs a search for the selected stimulus.	

Manual RT testing	
If you are using OTOsuite: – In the Reflex Threshold screen, click Start on the Control Panel.	
If you are using MADSEN OTOflex 100: – Press the right-hand softkey.	
If needed, repeat testing of more stimulus levels.	

Pausing the test	
– To interrupt the test, click/press Pause . – To resume the test, click/press Pause again. After the pause, the test resumes at the intensity it came to or was interrupted in.	
7. When you have finished testing one ear, switch ears, if needed.	
8. To continue testing, click/press Start and test the other ear.	

The test progresses as follows	
<ul style="list-style-type: none"> <i>If a threshold is not found immediately:</i> The stimulus intensities will increase until a reflex threshold is registered or until the max. intensity is reached. 	
<ul style="list-style-type: none"> <i>If a threshold is found immediately:</i> The test will automatically decrease the stimulus intensities until a threshold is no longer registered. 	
<ul style="list-style-type: none"> <i>Deflection curves</i> The deflection curves result in a complete reflex deflection graph. The curves shown are sorted according to increased stimulus intensity. 	
<ul style="list-style-type: none"> <i>Thresholds table</i> Shows the determined threshold. If no threshold is detected, the field in the Thresholds table will show the text None to indicate the absent threshold. 	
<ul style="list-style-type: none"> <i>Tympanogram</i> If available, the most recent tympanogram for the currently used probe tone is displayed, and a marker on the pressure axis indicates the current ear canal pressure. The curve number is also indicated. 	
<p>The following symbols are used in the audiogram:</p> <ul style="list-style-type: none"> – Pure tone air unmasked/masked – Pure tone bone unmasked/masked – Ipsi Thr. found/not found – Contra Thr. found/not found (Stim: x) 	

Continuing the test	
9. If you repeat a measurement at a specific intensity, the previous measurement for that intensity will be overwritten. You cannot see several curves with the same intensity.	
10. To make a new sweep, click/press Start . You can save up to 3 separate measurements for each ear.	
11. When you have finished testing one ear, switch ears, if needed.	
12. To continue testing, click/press Start and test the other ear.	

Reflex Threshold field results

- If a field shows a value with no extra marks, the threshold has been determined automatically.
- If a field is crossed out, this indicates that no threshold has been detected at this highest test level.
- If a field is marked by an asterisk, the threshold has been manually determined.
- Blank fields indicate that the test has not been performed.

- The dashed horizontal line in each reflex graph indicates the predefined reflex criterion. It is offset from the base line marker on the vertical axis.

15.2 Reflex Decay testing

Note • With MADSEN OTOflex 100, automatic or semi-automatic testing automatically determines acoustic reflexes using different stimulus levels.
 The decay test stimulus level pre-supposes that there is a reflex threshold available for the ear, stimulus type and stimulus ear (ipsi- or contralateral) that is chosen for reflex decay testing. The decay test stimulus level will then automatically be set to the threshold level +10 dB. If the reflex has not been determined, the decay measurement will be skipped.

Max. intensity levels

There may be a warning that the stimulus level is in the extended intensity range. Reflex decay may not be possible due to highly elevated threshold levels.

Max. intensity levels	500 Hz	1000 Hz
Ipsi	50 to 105 dB HL ± 3 dB	50 to 120 dB HL ± 3 dB
Contra	50 to 115 dB HL ± 3 dB	50 to 120 dB HL ± 3 dB

Before reflex testing

1. Do as described in [Preparing for testing](#) ► 17.
2. Warn the patient about the high stimulus levels in the test.
3. Ask the patient to sit very still and quiet during the test, without moving head or jaw.
4. If contralateral stimulation is used in the test, make sure that both the ipsilateral probe and the contralateral phone are in place before you start the measurement.
5. If needed, toggle the **Ear Selector** to select the ear on which you wish to start the test.
6. Select the Reflex Decay test screen.





The initial reflex threshold test screen is shown with ipsilateral 1 kHz stimulus highlighted.

During testing

Warning • If the patient is troubled by the test, stop the test. The test is interrupted and the pump pressure is relieved immediately. Already measured results are kept.



Procedure

Automatic RD testing	
If you are using OTOsuite: <ul style="list-style-type: none"> – In the Reflex Decay screen, click Start on the Control Panel. 	
If you are using MADSEN OTOflex 100: <ul style="list-style-type: none"> – Press the right-hand softkey. 	
The test runs a fully automatic reflex decay measurement for the preset stimuli.	
Manual RD testing	
If you are using OTOsuite: <ul style="list-style-type: none"> – In the Reflex Decay screen, click Start on the Control Panel. 	
If you are using MADSEN OTOflex 100: <ul style="list-style-type: none"> – Press the right-hand softkey. 	
If needed, repeat testing of more stimulus levels.	
Pausing the test	
<ul style="list-style-type: none"> – To interrupt the test, click/press Pause. – To resume the test, click/press Pause again. After the pause, the test resumes at the intensity it came to or was interrupted in. 	
7. When you have finished testing one ear, switch ears, if needed.	
8. To continue testing, click Start and test the other ear.	

The test progresses as follows	
<p><i>Deflection graph</i></p> <p>The deflection graph is limited by blue markers indicating stimulus on and off.</p> <p>A third marker appears as indication of the half-life time where the curve decreases to 50% of its initial deflection.</p>	
<ul style="list-style-type: none"> <p><i>Half-life time, seconds - Results table</i></p> <p>If the deflection decreases to 50% or more of the initial deflection during presentation of the stimulus, the point in time when this occurs is shown.</p> <p>If no decay is registered, the field shows a dash.</p> <p>The Ipsi results are shown in the top row. The contra-lateral results referring to the stimulus ear are shown in the bottom row.</p> 	
<ul style="list-style-type: none"> <p><i>Tympanogram</i></p> <p>If available, the most recent tympanogram for the currently used probe tone is displayed, and a marker on the pressure axis indicates the current ear canal pressure.</p> <p>The curve number is also indicated.</p> 	

Continuing the test	
9. When you have finished testing one ear, switch ears, if needed.	
10. To continue testing, click/press Start and test the other ear.	

Reflex Decay field results

- When the measurement is completed, the result fields show the detected half-life time for each stimulus.
- The unbroken line above the graph indicates the duration of the stimulus.
- The dashed line is the x-axis and indicates the total duration of the measurement.

Measurements saved







Since a reflex decay measurement typically is made using either ipsilateral or contralateral stimulus side (not both), only two measurements are saved, i.e. different stimuli and/or ipsi/contra.

15.3 ETF-P (Eustachian Tube Function - Perforated)

Before testing

1. Do as described in [Preparing for testing](#) ► 17.
2. Ask the patient to sit very still and quiet during the test, without moving head or jaw.
3. If needed, toggle the **Ear Selector** to select the ear on which you wish to start the test.

During testing

Procedure	
1. Record a tympanogram to confirm the perforation. The resulting tympanogram curve will be flat, and the ear canal volume will be abnormally high because it includes the volume of the entire middle ear.	
2. Select the ETF-P test screen.	
If you are using OTOSuite: – In the ETF-P screen, click the Pressure Control button on the Control Panel to start testing.	
If you are using MADSEN OTOflex 100: – Press the right-hand softkey.	
If Initial pressure is set to Positive , the pressure control points upwards.	 or 
If Initial pressure is set to Negative , the pressure control points downwards.	 or 
3. Activate Pressure Up or Pressure Down to automatically build up pressure until the first opening of the Eustachian tube or max. pressure is reached. The pressure control is automatically reversed after one of the two criteria has been reached.	

The ETF-P result

- *The time-pressure graph*
The ETF-P test result shows how the pressure changes throughout the measurement as the Eustachian tube briefly opens and closes.
- One curve per ear is saved.
- *Eustachian tube openings, daPa*
The pressure values denoting the openings and closings of the Eustachian tube are determined from the plateaus of the curve.
- For a more extensive analysis, use the OTOSuite ETF-P post-analysis tool to retrieve the numerical pressure values (see the MADSEN OTOflex 100 Reference Manual).

16 Managing test results in MADSEN OTOflex 100

The following applies to managing test results in MADSEN OTOflex 100. If you wish to perform these actions in OTOSuite, see the OTOSuite User Guide or OTOSuite Reference Manual

Swapping ear results

If you have tested a patient with the wrong ear selected, you can swap the ear results both during a session and after a session so that the results are assigned to the other ear. Swapping applies to all tests made on that patient.

- Select **Menu > Manage Test Res > Swap ear results**

Deleting measurements

Tympanometry

You can delete a single sub-test/curve, either from a multi-curve graph or from a multiple-graph action from the grid.

1. Toggle to select one of the curve or graph numbers in this icon group if you want to view a specific curve or graph. The curve will be highlighted.
2. To delete a curve, select **Menu > Manage Test Res > Del Sub-test**.

Reflex Threshold

In Reflex Threshold you cannot delete a single curve, only a complete test including all the stimulus intensities for the selected stimulus type.

Deleting Test Results

Deleting current test

- To delete the current test, select **Menu > Manage Test Res > Del(ete) Current Test**.

Deleting individual patients

- To delete the specific, individual patients, select **Menu > Manage Test Res > Del Patient**. Scroll to select the specific patient and press **Select** to delete.

Deleting all printed patients

If you wish to delete all printed patients, select **Menu > Manage Test Res > Del all printed patients**.

Deleting all patients

- If you wish to delete all patients, select **Menu > Manage Test Res > Del all patients**.

Uploading test results to OTOSuite

you can transfer patient folders from MADSEN OTOflex 100 to OTOSuite.

1. In the Immittance module click the **Get Test Results** icon.
If Bluetooth communication is enabled in MADSEN OTOflex 100, OTOSuite automatically connects to MADSEN OTOflex 100 to get data and then disconnects. If online, it uses the already established connection.
2. Select from the dialog box shown.

Communicating and synchronizing with OTOSuite

From OTOSuite

When MADSEN OTOflex 100 is within range of OTOSuite and you click the **Select Device** icon in the Immittance module, MADSEN OTOflex 100 connects while the transfer is active and then disconnects. If online, it uses the already established connection.

If you click **Select Device** in the Immittance module, data is synchronized. If the patient folder is not the same in the Immittance module and MADSEN OTOflex 100, you will be prompted to select the patient folder.

Each test is identified by a timestamp, the patient name, gender, date of birth, the type of test done on a specific ear, and the name of the tester.

If data is already available in OTOSuite, you will be prompted to either overwrite the data or cancel.

Synchronizing data

From MADSEN OTOflex 100 Data is usually transferred from MADSEN OTOflex 100 to OTOSuite. Data is never deleted without confirmation from the user.

Synchronization takes just a few seconds and is usually automatically initiated upon connection.

Note • Only the patient folder currently shown in MADSEN OTOflex 100 will be transferred to OTOSuite during synchronization.

Other patient folders created while MADSEN OTOflex 100 was off-line must be transferred manually.

Synchronization of changes made in patient folders

Changes made in patient folders, either in MADSEN OTOflex 100 or in the Immittance module, will be synchronized.

The most recent change, regardless of whether it was made in MADSEN OTOflex 100 or in the Immittance module, will be applied or synchronized.

17 Other references

For more information, see the online Help in OTOSuite, which contains detailed reference information about MADSEN OTOflex 100 and the OTOSuite modules.

For OTOSuite installation instructions, see the OTOSuite Installation Guide, on the OTOSuite installation medium.

In-depth information about using MADSEN OTOflex 100 can be found in the MADSEN OTOflex 100 Reference Manual.

18 Service, cleaning and calibration

Warning • Under no circumstances disassemble MADSEN OTOflex 100. Contact your supplier. Parts inside MADSEN OTOflex 100 must only be checked or serviced by authorized personnel.

18.1 Service

Warning • For the sake of safety and in order not to void the warranty, service and repair of electro-medical equipment should be carried out only by the equipment manufacturer or by service personnel at authorized workshops. In case of any defects, make a detailed description of the defect(s) and contact your supplier. Do not use a defective device.

18.2 Cleaning the device

Prerequisites

- Before cleaning, switch off MADSEN OTOflex 100 and disconnect it from any external power source.
- Unplug the probe from MADSEN OTOflex 100.

The device

- Remove dust using a soft brush.
- Use a soft, slightly damp cloth with a small amount of mild detergent or approved non-caustic medical grade disinfectant wipes to clean the unit according to local infection control regulations.

Keep the unit away from liquids. Do not allow moisture inside the unit. Moisture inside the unit can damage the instrument and it may result in a risk of electrical shock to the user or patient.

Clean the device screen periodically. Use an anti-static non-solvent solution on a lint-free cloth.

The probe tip

See [Cleaning and disinfecting the test cavity](#) ► 39.

Disposal

There are no special requirements for the disposal of eartips, i.e. they can be discarded according to local regulations.

18.3 Cleaning and disinfecting the probe tip

Ear canal debris blocking the probe tubes can lead to abnormally large ear canal volume readings, leak messages, and other odd results. Check the channels of the probe tip every time you use the probe. Even small amounts of cerumen or vernix can block the probe channels.

Caution • Thorough cleaning of the probe tip is required after use in infected ear canals. Cleaning the threaded ring may also be necessary.

Methods

The probe tip material is highly resistant to a wide range of temperature and chemical influences.



Caution • The probe body contains sensitive components. Never clean the sound channels in the probe body mechanically or with liquids. Doing so may cause damage to the probe.

Regular cleaning

- Use a wet tissue for regular surface cleaning.

Ultrasonic cleaning

- Use ultrasonic cleaning to remove contaminants, for instance before autoclaving.

Disinfecting

You can choose between a number of methods for disinfecting the probe tip, for instance:

- Immersion of the probe tip in a bath of 70-90% ethyl or isopropyl alcohol for 10-30 minutes contact time.
- Immersion of the probe tip in a Sodium Hypochlorite solution at high concentrations and extended contact time (considered a cold sterilant).

When you have cleaned the probe tip, rinse it thoroughly in regular water.

Autoclaving

Use autoclaving in accordance with the national standards for vapour cleaning with an exposure time of up to 45 minutes at a maximum temperature of 150°C.

The probe tip is designed to withstand up to 3,000 autoclaving cycles in which temperatures typically reach 134°C.

Make sure that the probe tip has not been deformed by the autoclaving process.

Procedure

Note • Always comply with local hygienic standards for disinfection.

1. To remove the probe tip, hold the probe by the probe body and unscrew the threaded ring. Take out the probe tip.

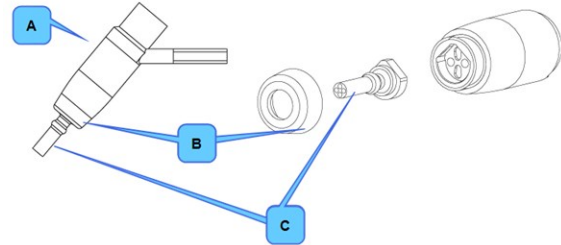

- A. Probe body
- B. Threaded ring
- C. Probe tip

2. Check to see if the sound channels of the probe tip are blocked. If they are, use the cleaning wire to clean the sound channels.

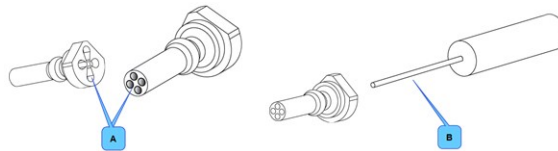

- A. Sound channels
- B. Cleaning wire

Always clean from the rear.

3. If you are cleaning the probe tip *during a session testing a patient*, use the cleaning brush to clean the cleaning wire, especially where it protrudes from the probe tip.

If you are cleaning the probe tip *between sessions*, use disinfectant to clean the cleaning wire, and, if needed, the brush.

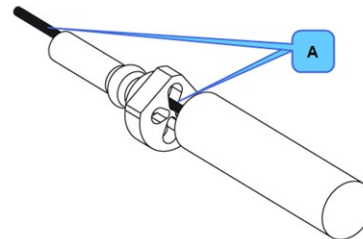

- A. Cleaning wire

Caution • *Even the slightest amount of moisture may dissolve any residual cerumen and thus contaminate the sensitive parts in the body of the probe.*

Caution • *Never clean the sound channels in the probe body, as this may cause damage to the probe.*



4. Make sure that the sound channels are completely dry before fitting the tip back into the probe body, or use a spare probe tip.
5. Fit the probe tip and screw the threaded ring firmly back onto the probe body. Tighten well to prevent leakage.

Changing the wax filter

If you are warned that there is a probe error, or that the probe is not OK, check whether the probe tip is blocked. If it is not, the wax filter of the probe may be damaged or blocked by cerumen.

If this is the case, change the wax filter:

1. To replace the wax filter, remove the probe tip.
2. Use the extraction pin to remove the wax filter from the probe tip.

Do not put used filters in the accessory box.

Filters are disposable.

3. Insert a new filter. Be careful not to damage the filter openings.
4. Fit the probe tip over the new filter in the probe body and screw the threaded ring back onto the probe body. Tighten well.

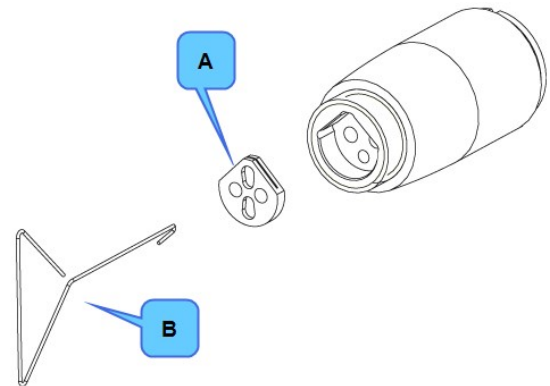

- A. Wax filter
B. Extraction lever

18.4 Cleaning and disinfecting the test cavity

Caution • The test cavity is located in the charger, which contains electrical components and electrical power connection. Therefore: **do not** use bath or autoclaving!

If the test cavity has been contaminated with debris from the probe tip, use gas cleaning according to local hygienic standards (i.e. with ethyleneoxide, at a temperature of 55°C, at a pressure of 0.8 to 1.0 bar).

18.5 Calibration

The device and the probes are delivered fully calibrated.

- The device is calibrated from the factory in dB SPL or dB HL using the stated reference equivalent thresholds. dB HL are related to sound pressure levels, dB SPL = dB re 20 μ Pa.
- The probe calibration values are saved in the probe assembly and follows the probe. The probe can be plugged to any MADSEN OTOflex 100 and used right away. This also applies to the contra insert phone.

Annual calibration

The immittance device and probes must be calibrated once a year by your authorized service department.

19 Technical specifications

Type identification

MADSEN OTOflex 100 is type 1012 from Natus Medical Denmark ApS

Compliance measuring system

Probe tone:	226 Hz at 85dB SPL \pm 1.5 dB 1000Hz at 75dB SPL \pm 1.5 dB
THD:	< 3% in 2 cc
Frequency accuracy:	\pm 0.5%
Range:	0.1 ml to 8.0 ml \pm 5% or 0.1 ml, whichever is greater

Acoustic reflex

Contralateral Stimulation

Pure tones:	500 Hz, 1000 Hz, 2000 Hz, 3000 Hz, 4000 Hz
Frequency accuracy:	\pm 0.5%
Noise	White Noise according to IEC 1027 Low Pass 400 to 1600 Hz. High Pass 1600 to 4000 Hz. Roll off >12 dB/Octave.
Range at:	BBN, LPN at 50 to 100 dB HL \pm 3 dB HPN at 50 to 95 dB HL \pm 3 dB
Step size dB	1, 2, 5, 10 dB

E-A-RTONE® 3A:

Range at:	500 Hz at 50 to 105 dB HL \pm 3 dB 1000 Hz at 50 to 120 dB HL \pm 3 dB 2000 Hz at 50 to 115 dB HL \pm 3 dB 3000 Hz at 50 to 105 dB HL \pm 3 dB 4000 Hz at 50 to 110 dB HL \pm 3 dB
THD:	< 3% in 2 cc (measured 5 dB below max output)

Immittance probe:

Range at:	500 Hz at 50 to 105 dB HL \pm 3 dB 1000 Hz at 50 to 120 dB HL \pm 3 dB 2000 Hz at 50 to 115 dB HL \pm 3 dB 3000 Hz at 50 to 105 dB HL \pm 3 dB 4000 Hz at 50 to 110 dB HL \pm 3dB
THD:	< 3% in 2 cc (measured 5 dB below max output)

Ipsilateral Stimulation

Tone:	500 Hz, 1000 Hz, 2000 Hz, 3000 Hz, 4000 Hz
Frequency accuracy:	\pm 0.5%
Noise	White Noise according to IEC 1027 Low Pass 400 to 1600 Hz High Pass 1600 to 4000 Hz Roll off >12 dB/Octave
Step size dB:	1, 2, 5, 10 dB
Range at:	500 Hz at 50 to 105 dB HL \pm 3 dB 1000 Hz at 50 to 120 dB HL \pm 3 dB 2000 Hz at 50 to 115 dB HL \pm 3 dB 3000 Hz at 50 to 105 dB HL \pm 3 dB 4000 Hz at 50 to 110 dB HL \pm 3 dB
THD:	< 3% in 2 cc (measured 5 dB below max output)

Air pressure system

Range:	Normal +200 to -400 daPa/s, Extended +400 to -600 daPa/s
Pressure sweep rate:	50, 100, 200, 400 daPa/s, A.F.A.P A.F.A.P. will start at 500 daPa/s and slow down to 400 daPa, when at peak is detected.
Pressure accuracy:	\pm 10% or \pm 10 daPa, whichever is greatest
Pump measure direction:	Positive to negative or negative to positive
Safety:	Separate safety +530 daPa and -730 daPa. \pm 70 daPa Software safety +450 daPa and -650 daPa. \pm 70 daPa.

Unit of admittance graph Y-axisml, cc, mmho, μ l**Unit of graph X-axis**

daPa, s

Display

Graphic 128x128 dots

BT antenna

BT antenna: Chip multilayer antenna for 2.4 GHz
Antenna gain: 2 dBi
Antenna impedance: 50 Ohm

The device supports Bluetooth SIG standards and uses features and functions from connected peripherals such as displaying the working status on the console from a Bluetooth connection.

The device with Bluetooth technology, which operates in the same spectrum range in the 2.400 GHz-2.4835GHz (ISM band) as Classic Bluetooth technology, uses Bluetooth technology's 79 1-MHz wide channels. Within the channel, data is transmitted using Gaussian frequency shift modulation (GFSK), similar to Classic Bluetooth's Basic Rate scheme. The bit rate is 1 Mbit/s.

Power supply

Battery types: Rechargeable (Ni-MH type) 1.2 V, or Alkaline AA (R6) 1.5 V, 4 pcs.
Use only rechargeable batteries supplied by Natus Medical Denmark ApS.
Battery supply voltage: Nom. 5 V, max. 6.4 V, min. 4.0 V (instrument power-off voltage)

Operating environment

Temperature: +15°C to +35°C (59°F to +95°F)
Rel. humidity: 30 to 90 %, non-condensing
Warm-up time: < 2 min.
Air pressure: 600 hPa to 1060 hPa

Operation at temperatures below -20°C or above +60°C may cause permanent damage.

Storage and handling

Temperature: -20°C to +60°C (-4°F to +140°F)
Rel. humidity: < 90 %, non-condensing
Air pressure: 500 hPa to 1060 hPa

Dimensions

MADSEN OTOflex 100 (HxWxD): 20 cm x 4.9 cm x 7.8 cm (7.9" x 1.9" x 3.0")
Charger unit (HxWxD): 18 cm x 4.9 cm x 7.8 cm (6.9" x 1.9" x 3.0")

Weight

MADSEN OTOflex 100: 0.6 kg/1.3 lb
Charger unit: 0.23 kg/0.5 lb

Charger unit

Type identification:	Charger unit is type 1012 Charger from Natus Medical Denmark ApS
Power:	100 - 240 VAC \pm 10%, 50/60 Hz
Power consumption	< 10 VA

Miscellaneous

2cc coupler
Clock and calendar

Calibration

Equipment should be calibrated regularly according to EN 61027 and ANSI S3.39

Essential performance

MADSEN OTOflex 100 has no essential performance and accordingly, the applicable requirements are as stated in the following:

1. Impedance/admittance as defined by EN 61027 Type 1, ANSI S3.39 Type 1.
2. Basic safety as defined by IEC 60601-1.

All information required by IEC 60601-1-2:2007, #5.2.2.1-#5.2.2.10 is available in the MADSEN OTOflex 100 User Guide.

Standards

Safety:	ANSI/AAMI ES 60601-1 (2005), CAN/CSA -C22.2 NO 60601.1 (2008) MADSEN OTOflex 100: IEC 60601-1, Class II, Internal Powered, Type BF, IPX0 Charger unit: EN 60601-1, Class II, IPX0
EMC:	EN 60601-1-2, EN 300 328-2, EN 301 489-17
Impedance/Admittance:	EN 61027 Type 1, ANSI S3.39 Type 1

19.1 Accessories

- Immittance probe
- Probe tips
- Eartips
- Eartip box
- Otometrics insert phone, contralateral
- Contralateral phone, TDH-39
- Inserts for contralateral phones
- Shoulder harness
- OTOSuite SW installation disk
- Power cord
- MADSEN OTOflex 100 User Guide
- MADSEN OTOflex 100 Reference Manual

- Wall-mount kit for PC-based device
- Probe cleaning kit
- Carrying case
- Wax filter kit
- NiMH rechargeable batteries
- Bluetooth USB printer adapter
- OTOair Bluetooth dongle
- Charger/cradle
- Device cap
- E-A-Rtone tube nipples

19.2 Notes on EMC (Electromagnetic Compatibility)

- MADSEN OTOflex 100 is part of a medical electrical system and is thus subject to special safety precautions. For this reason, the installation and operating instructions provided in this document should be followed closely.
- Portable and mobile high-frequency communication devices, such as mobile phones, may interfere with the functioning of MADSEN OTOflex 100.

Guidance and manufacturer's declaration - electromagnetic emissions for all equipment and systems		
MADSEN OTOflex 100 is intended for use in the electromagnetic environment specified below. The user of MADSEN OTOflex 100 should ensure that it is used in such an environment.		
Emissions test	Compliance	Electromagnetic environment - guidance
RF emissions CISPR11	Group 1	MADSEN OTOflex 100 uses RF energy only for its internal function. Therefore, its RF emissions are very low and are not likely to cause any interference in nearby electronic equipment. MADSEN OTOflex 100 is suitable for use in all environments, including domestic environments and those directly connected to the public low-voltage power supply network that supplies buildings used for domestic purposes.
RF emissions CISPR11	Class B	
Harmonic emissions IEC 61000-3-2	Not applicable	
Voltage fluctuations/flicker emissions IEC 61000-3-3	Not applicable	

Guidance and manufacturer's declaration - electromagnetic immunity for all equipment and systems			
MADSEN OTOflex 100 is intended for use in the electromagnetic environment specified below. The user of MADSEN OTOflex 100 should ensure that it is used in such an environment.			
Immunity test	IEC 60601 test level	Compliance level	Electromagnetic environment - guidance

Electrostatic discharge (ESD) IEC 61000-4-2	+/- 6 kV contact +/- 8 kV air	+/- 6 kV contact +/- 8 kV air	Floors should be wood, concrete or ceramic tile. If floors are covered with synthetic material, the relative humidity should be at least 30 %.
Electrical fast transient/burst IEC 61000-4-4	+/- 2 kV for power supply lines +/- 1 kV for input/output lines	+/- 2 kV for power supply lines +/- 1 kV for input/output lines	Mains power quality should be that of a typical commercial or hospital environment.
Surge IEC 61000-4-5	+/- 1 kV line(s) to line(s) +/- 2 kV line(s) to earth	+/- 1 kV line(s) to line(s) +/- 2 kV line(s) to earth	Mains power quality should be that of a typical commercial or hospital environment.
Voltage dips, short interruptions and voltage variations on power supply input lines IEC 61000-4-11	<5 % U_T (>95 % dip in U_T) for 0.5 cycle 40 % UT (60 % dip in U_T) for 5 cycles 70 % U_T (30 % dip in U_T) for 25 cycles <5 % U_T (>95 % dip in U_T) for 5 s	<5 % U_T (>95 % dip in U_T) for 0.5 cycle 40 % UT (60 % dip in U_T) for 5 cycles 70 % U_T (30 % dip in U_T) for 25 cycles <5 % U_T (>95 % dip in U_T) for 5 s	Mains power quality should be that of a typical commercial or hospital environment. If the user of the MADSEN OTOflex 100 requires continued operation during power mains interruptions, it is recommended that the MADSEN OTOflex 100 be powered from an uninterruptible power supply or a battery.
Power frequency (50/60 Hz) magnetic field IEC 61000-4-8	3 A/m	3 A/m	Power frequency magnetic fields should be at levels characteristic of a typical location in a typical commercial or hospital environment.
<p>U_T is the AC mains voltage prior to application of the test level.</p>			

Guidance and manufacturer's declaration - electromagnetic immunity - for equipment and systems that are NOT life-supporting

MADSEN OTOflex 100 is intended for use in the electromagnetic environment specified below. The user of MADSEN OTOflex 100 should ensure that it is used in such an environment.

Immunity test	IEC 60601 test level	Compliance level	Electromagnetic environment - guidance
---------------	----------------------	------------------	--

19 Technical specifications

Conducted RF IEC 61000-4-6	3 V rms 150 kHz to 80 MHz	3 V rms 150 kHz to 80 MHz	Portable and mobile RF communications equipment should be used no closer to any part of MADSEN OTOflex 100, including cables, than the recommended separation distance calculated from the equation applicable to the frequency of the transmitter. Recommended separation distance: $d = 1.2\sqrt{P}$ $d = 1.2\sqrt{P}$ for 80 MHz to 800 MHz $d = 2.3\sqrt{P}$ for 800 MHz to 2.5 GHz,
Radiated RF IEC 61000-4-3	3 V/m 80 MHz to 2.5 GHz	3 V/m 80 MHz to 2.5 GHz	where P is the maximum output power rating of the transmitter in watts (W) according to the transmitter manufacturer and d is the recommended separation distance in metres (m). Field strengths from fixed RF transmitters, as determined by an electromagnetic site survey, ^a should be less than the compliance level in each frequency range. ^b Interference may occur in the vicinity of equipment marked with this symbol: 

Note 1: At 80 MHz and 800 MHz the separation distance for the higher frequency range applies.

Note 2: These guidelines may not apply in all situations. Electromagnetic propagation is affected by absorption and reflection from structures, objects and people.

- a. Field strengths from fixed transmitters, such as base stations for radio (cellular/cordless) telephones and land mobile radios, amateur radio, AM and FM radio broadcast and TV broadcast cannot be predicted theoretically with accuracy. To assess the electromagnetic environment due to fixed RF transmitters, an electromagnetic site survey should be considered. If the measured field strength in the location in which MADSEN OTOflex 100 is used exceeds the applicable RF compliance level above, the MADSEN OTOflex 100 should be observed to verify normal operation. If abnormal performance is observed, additional measures might be necessary, such as reorienting or relocating MADSEN OTOflex 100.
- b. Over the frequency range 150 kHz to 80 MHz, field strengths should be less than 3 V/m.

Recommended separation distances between portable and mobile RF communications equipment and MADSEN OTOflex 100			
The MADSEN OTOflex 100 is intended for use in an electromagnetic environment in which radiated RF disturbances are controlled. The customer or the user of the MADSEN OTOflex 100 can help prevent electromagnetic interference by maintaining a minimum distance between portable and mobile RF communications equipment (transmitters) and the MADSEN OTOflex 100 as recommended below, according to the maximum output power of the communications equipment.			
Rated maximum output power of transmitter W	Separation distance according to frequency of transmitter m		
	150 kHz to 80 MHz $d = 1.2\sqrt{P}$	80 MHz to 800 MHz $d = 1.2\sqrt{P}$	800 MHz to 2.5 GHz $d = 2.3\sqrt{P}$
0.01	0.12	0.12	0.23
0.1	0.38	0.38	0.73
1	1.2	1.2	2.3

10	3.8	3.8	7.3
100	12	12	23





For transmitters rated at a maximum output power not listed above, the recommended separation distance d in meters (m) can be estimated using the equation applicable to the frequency of the transmitter, where P is the maximum output power rating of the transmitter in watts (W) according to the transmitter manufacturer.

Note 1: At 80 MHz and 800 MHz the separation distance for the higher frequency range applies.

Note 2: These guidelines may not apply in all situations. Electromagnetic propagation is affected by absorption and reflection from structures, objects and people.





20 Definition of symbols

MADSEN OTOflex 100



	Complies with Type BF requirements of EN60601-1. See Technical Specifications, Standards in the OTOflex 100 guide.
	OTOflex 100 is marked with this symbol when it is important that the user is acquainted with the contents of this manual.
	Electronic equipment covered by the Directive 2012/19/EU on waste electrical and electronic equipment (WEEE). All electrical and electronic products, batteries, and accumulators must be taken to separate collection at the end of their working life. This requirement applies in the European Union. Do not dispose of these products as unsorted municipal waste. You can return your device and accessories to Natus Medical Denmark ApS, or to any Natus Medical Denmark ApS supplier. You can also contact your local authorities for advice on disposal.
	Classified with respect to electrical shock, fire, mechanical and other specified hazards only in accordance with UL 2601-1 and CAN/CSA-C22.2 NO 601.1-90.
	In France, it is only permitted to use the device indoors.
FCC	This device complies with part 15 of the FCC rules. Operation is subject to the following two conditions: <ul style="list-style-type: none"> • This device must not cause harmful interference. • This device must accept any interference received, including interference that may cause undesired operation. Refer to Notes 5 through 7 in the section Warning notes - 215 for more details.
IC	The term "IC" before the certification/registration number signifies that the Industry Canada technical specifications were met.

	<p>This device complies with Industry Canada license-exempt RSS standard(s). Operation is subject to the following two conditions: (1) this device may not cause interference, and (2) this device must accept any interference, including interference that may cause undesired operation of the device.</p> <p>This device complies with RSS standards of the Industry Canada Rules. Operation is subject to the following two conditions:</p> <ol style="list-style-type: none"> 1. 1. This device must not cause harmful interference, and 2. 2. This device must not accept any interference received, including interference that may cause undesired operation. <p>Important note <i>Radiation Exposure Statement</i></p> <p>This transmitter must not be co-located or operating in conjunction with any other antenna or transmitter.</p> <p>This equipment complies with Industry Canada RSS-102 with respect to Canada's Health Code 6 for Exposure of Humans to RF Fields.</p>
	<p>Interference may occur in the vicinity of the device. Local regulations and precautions for other equipment in the environment should always be followed to avoid interference.</p> <p>The separation distance from this device to other devices complying with standard immunity requirements in EN 60601-1-2 is minimum 0.35 m/1ft.</p> <p>For use in restricted areas the OTOflex 100 features the ability to turn off the built-in Bluetooth module, i.e. disabling the Bluetooth radio communication. OTOflex 100 has built-in storage capabilities to store data measured offline and these data can later be transferred in other locations.</p>
	<p>Symbols on buttons to operate OTOflex 100, see the section Controls and menu selections - 23 and 7 testing with MADSEN OTOflex 100- 63.</p>

Charger unit

	<p>Complies with Class II requirements of the safety standard IEC 60601-1:2005+AMD1:2012 and EN 60601-1:2006+A1:2013.</p>
	<p>Caution Indicates the need for the user to consult the instructions for use for important cautionary information such as warnings and precautions that cannot, for a variety of reasons, be presented on the medical device itself.</p>
	<p>Follow instructions for use</p>
	<p>UL recognized component for Canada and the United States</p>
	<p>Suitable for alternating current only.</p>

OTOSuite Immittance module



 XXXX	CE marking of conformity Complies with Medical Devices Directive 93/42/EEC
	Used in error message dialogs if software program fails. See the detailed information in the dialog box.

21 Warning notes

This manual contains information and warnings, which must be followed to ensure the safe performance of the devices and software covered by this manual. Local government rules and regulations, if applicable, should also be followed at all times.

See [MADSEN OTOflex 100 warning notes](#) ► 49 and [Charger unit warning notes](#) ► 50.

21.1 MADSEN OTOflex 100 warning notes

	<p>MADSEN OTOflex 100 should only be provided with prescribed battery types. See Technical Specifications. Place the batteries as indicated in the battery compartment, see Powering the device ► 7 for further details.</p> <p>Use only rechargeable batteries when MADSEN OTOflex 100 is placed in the charger unit. If you are using alkaline batteries, do not attempt to charge your MADSEN OTOflex 100. Your alkaline batteries may be damaged and leak, and this may in turn cause damage to MADSEN OTOflex 100.</p> <p>Batteries should be removed if equipment is not likely to be used for some time.</p>
	<p>MADSEN OTOflex 100 should only be connected to charger type 1012 Charger from Natus Medical Denmark ApS.</p>

1. For the sake of safety and in order not to void the warranty, service and repair of electro-medical equipment should be carried out only by the equipment manufacturer or by service personnel at authorized workshops. In case of any defects, make a detailed description of the defect(s) and contact your supplier. Do not use a defective device.
2. Accidental damage and incorrect handling can have a negative effect on the functionality of the device. Contact your supplier for advice.
3. Keep the unit away from liquids. Do not allow moisture inside the unit. Moisture inside the unit can damage the instrument and it may result in a risk of electrical shock to the user or patient.
4. Do not store or operate the device at temperatures and humidity exceeding those stated in the Technical Specifications, Transport and storage.
5. Do not use the instrument in the presence of flammable agents (gases) or in an oxygen-rich environment.
6. We recommend that the device should not be stacked with other equipment or placed in a poorly ventilated space as this may affect the performance of the device. If it is stacked or placed adjacent to other equipment, make sure that the operation of the device is not affected.

7. Unwanted noise may occur if the instrument is exposed to a strong radio field. Such noise may interfere with the process of recording correct measurements. Many types of electrical devices, e.g. mobile telephones, may generate radio fields. We recommend that the use of such devices in the vicinity of this instrument be restricted as much as possible.
8. Unwanted interference may occur from other equipment, even if the equipment complies with CISPR emission requirements.
9. For safety reasons and due to effects on EMC, accessories connected to the equipment's outlet fittings must be identical to the type supplied with the system.
10. Changes or modifications not expressly approved by the manufacturer could void the user's authority to operate the equipment.
11. This equipment has been tested and found to comply with the limits for a Class B digital device, pursuant to part 15 of the FCC Rules. These limits are designed to provide reasonable protection against harmful interference in a residential installation. This equipment generates, uses and can radiate radio frequency energy and, if not installed and used in accordance with the instructions, may cause harmful interference to radio communications. However, there is no guarantee that interference will not occur in a particular installation. If this equipment does cause harmful interference to radio or television reception, which can be determined by turning the equipment off and on, the user is encouraged to try to correct the interference by one or more of the following measures:
 - Reorient or relocate the receiving antenna.
 - Increase the separation between the equipment and receiver.
 - Connect the equipment into an outlet on a circuit different from that to which the receiver is connected.
 - Consult the dealer or an experienced radio/TV technician for help.
12. For use in Canada: To prevent radio interference to the licensed service, this device is intended to be operated indoors and away from windows to provide maximum shielding. Equipment (or its transmit antenna) that is installed outdoors is subject to licensing.
13. No parts may be eaten, burnt, or in any way used for purposes other than the applications defined in the Intended Use section of this manual.
14. The device and charger unit can be disposed of as normal electronic waste, according to local regulations. Please investigate local regulations concerning the disposal of rechargeable and alkaline batteries. Local government rules and regulations, if applicable, should be followed at all times.
15. If the device is not to be used for a period of time, remove the batteries from the device in order to prevent battery leakage.
16. For safety reasons and due to effects on EMC, accessories connected to the equipment's outlet fittings must be identical to the type supplied with the system.
17. It is recommended that an annual calibration be performed on accessories containing transducers. Furthermore, it is recommended that calibration be performed if the equipment has suffered any potential damage (e.g. headphones dropped on the floor).

Note that calibration has been performed only on the transducers supplied! If you wish to use any other transducer for testing with the device, please contact your local distributor first.
18. To comply with EN 60601-1-1 computer and printer must be placed out of reach of the client, i.e. not closer than approx. 1.5 meters/5 ft.

21.2 Charger unit warning notes



In order to disconnect the charger unit from the electrical power supply the power cable must be detached from the power source.

1. There are no user-serviceable parts inside the charger unit cabinet. For the sake of safety, and in order not to void the warranty, the cabinets should only be opened and serviced by authorized service personnel. In case of defects, please make a detailed description of the defect(s) and contact your supplier. Do not use a defective instrument.
2. The device can be disposed of as normal electronic waste, according to local regulations.

22 Manufacturer

Natus Medical Denmark ApS
Hoerskaetten 9, 2630 Taastrup
Denmark
☎ +45 45 75 55 55
www.natus.com

22.1 Responsibility of the manufacturer

The manufacturer is to be considered responsible for effects on safety, reliability, and performance of the equipment only if:

- All assembly operations, extensions, re-adjustments, modifications or repairs are carried out by the equipment manufacturer or personnel authorized by the manufacturer.
- The electrical installation to which the equipment is connected complies with EN/IEC requirements.
- The equipment is used in accordance with the instructions for use.

The manufacturer reserves the right to disclaim all responsibility for the operating safety, reliability and performance of equipment serviced or repaired by other parties.

